

BUSHING OPTIONS

B1 THD STD
B2 NON-THD

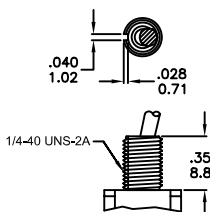

B3 THD
B4 NON-THD

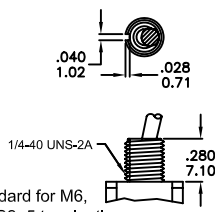

B4 is standard for M6, M7 and VS2-5 termination options.

B5 HIGH TORQUE

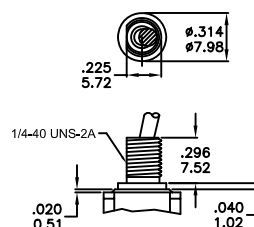

B6 HIGH TORQUE

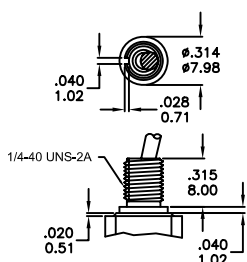

B7 THD STD

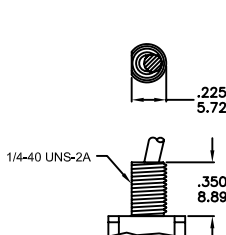

B8 METRIC THD

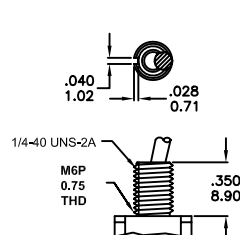

B9 SPLASH PROOF

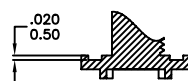
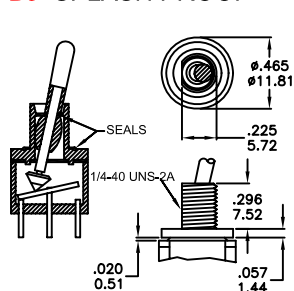

CP-1TB9

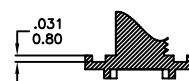
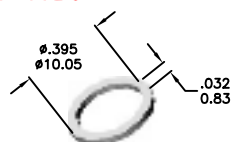

CP-1TEB

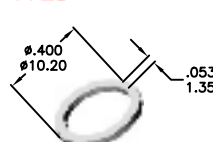

O-ring supplied with B9 bushing

B11 THD STD
B12 NON-THD

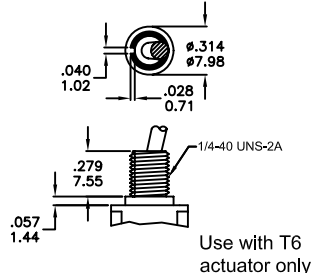

Use with T6 actuator only

B15 THD STD
B16 NON-THD

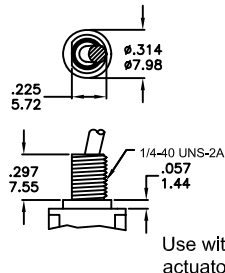

Use with T6 actuator only

B17

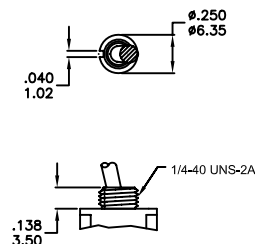

B13

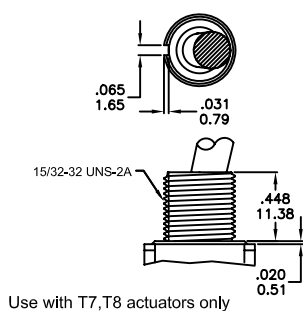

Use with T7,T8 actuators only

B18

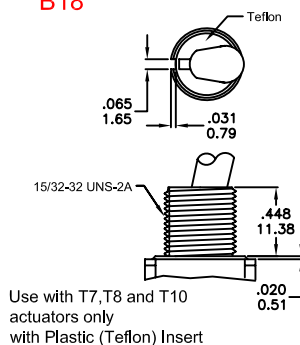

Use with T7,T8 and T10 actuators only with Plastic (Teflon) Insert

B20

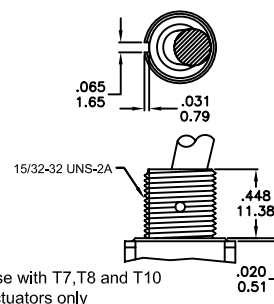

Use with T7,T8 and T10 actuators only

B 13 Bear Strength from top of actuator up to 10kg
aside up to 15kg

B 18 B 20 Bear Strength from top of actuator up to 20kg
aside up to 15kg