

SPECIFICATIONS

CONTACT RATING: Dependent upon contact material See page 17.

MECHANICAL LIFE: 30,000 make-and-break cycles.

CONTACT RESISTANCE: 10 mΩ max. initial @ 2-4VDC
100mA for both silver and gold plated contacts.

INSULATION RESISTANCE: 1,000 MΩ min.

DIELECTRIC STRENGTH: 1,000 Vrms min.@sea level.

OPERATING TEMPERATURE: -40°C to 85°C.

MATERIALS

CASE & BUSHING: Glass filled nylon 6/6, flame retardant, heat stabilized (UL94v-0).

ACTUATOR: Brass, chrome plated with internal, O-ring seal standard.

SWITCH SUPPORT: Brass or steel, tin plated.

SWITCH SUPPORT RETAINER: Stainless steel.

CONTACT / TERMINALS: Copper alloy, with Silver or gold plated.

(See Page 17)

IP 67
ACCORDING TO
EN 60529:1991+A1:2001
IEC 60529:2001



HOW TO ORDER

MODEL NO.	ACTUATOR	BUSHING	TERMINATIONS	TERMINAL PLATING	SEAL	RoHS SOLDERING
Model NO. 1AS1 SP ON-NONE-ON 1AS2 SP ON-NONE-(ON) 1AS3 SP ON-OFF-ON 1AS4 SP (ON)-OFF-(ON) 1AS5 SP ON-OFF-(ON) 1AD1 DP ON-NONE-ON 1AD2 DP ON-NONE-(ON) 1AD3 DP ON-OFF-ON 1AD4 DP (ON)-OFF-(ON) 1AD5 DP ON-OFF-(ON) 1AD6 DP ON-ON-ON 1AD7 DP (ON)-ON-(ON) 1AD8 DP ON-ON-(ON) 1A31 3P ON-NONE-ON 1A32 3P ON-NONE-(ON) 1A33 3P ON-OFF-ON 1A34 3P (ON)-OFF-(ON) 1A35 3P ON-OFF-(ON)	Actuator T1 12.70 high T2 7.62 high TA Plastic, black 12.70 high TB Plastic, black 7.62 high TC Plastic, silver 12.70 high	Bushing B1 8.89 high B4 6.10 high	Terminations M1 Solder Lug M2 PC thru-hole M51 18.70 high, wire wrap M52 24.20 high, wire wrap M53 10.55 high, wire wrap M54 26.97 high, wire wrap M6 Right angle, PC thru-hole M6N Right angle, snap-in, PC thru-hole M7 Vertical right angle, PC thru-hole VS2 11.68 high, V-bracket V2N 11.68 high, snap-in V-bracket VS3 16.00 high, V-bracket	Terminal plating Q Gold flash over silver R Gold C Gold over silver	Seal E EPOXY (std)	RoHS soldering S RoHS & Lead Free

SWITCH FUNCTION

NO. POLES	UL/CSA MODEL NO.	MODEL NO.	SWITCH FUNCTION			CONNECTED TERMINALS / SCHEMATIC				
			POS.1	POS.2	POS.3	POS.1	POS.2	POS.3		
SP	Q11A11	1AS1	ON	NONE	ON		N/A	2-1		
	Q11A12	1AS2	ON	NONE	(ON)					
	Q11A13	1AS3	ON	OFF	ON		OPEN			
	Q11A14	1AS4	(ON)	OFF	(ON)					
	Q11A15	1AS5	ON	OFF	(ON)					
DP	Q11A21	1AD1	ON	NONE	ON		N/A	2-1,5-4		
	Q11A22	1AD2	ON	NONE	(ON)					
	Q11A23	1AD3	ON	OFF	ON		OPEN			
	Q11A24	1AD4	(ON)	OFF	(ON)					
	Q11A25	1AD5	ON	OFF	(ON)					
	▲	Q11A26	1AD6	ON	ON		ON	2-3,5-6	2-3,5-4	2-1,5-4
	▲	Q11A27	1AD7	(ON)	ON		(ON)			
	▲	Q11A28	1AD8	ON	ON		(ON)			
3P	Q11A31	1A31	ON	NONE	ON		N/A	2-1,5-4,8-7		
	Q11A32	1A32	ON	NONE	(ON)					
	Q11A33	1A33	ON	OFF	ON		OPEN			
	Q11A34	1A34	(ON)	OFF	(ON)					
	Q11A35	1A35	ON	OFF	(ON)					

() = MOMENTARY

▲ Please check the availability in advance before order

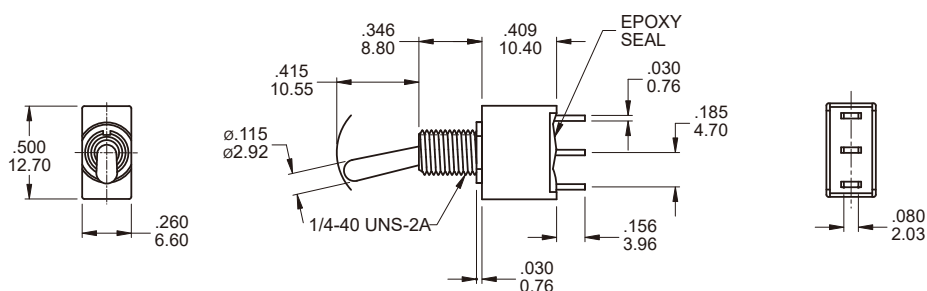
POLE OPTIONS

SPDT

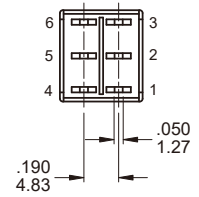
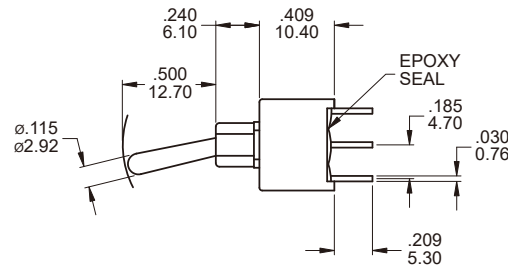
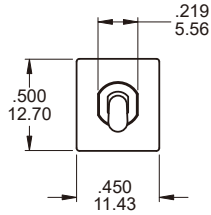
Part No. Shown : 1AS1T1B1M1QES

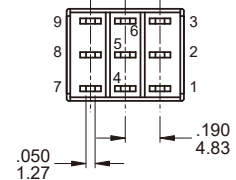
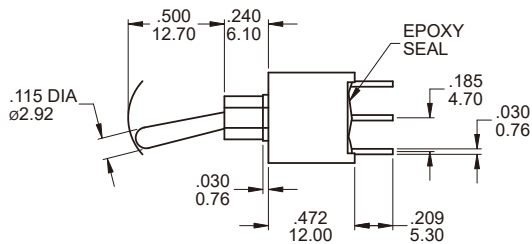
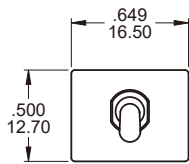

DPDT

Part No. Shown : 1AD1T1B4M2QES



3PDT

Part No. Shown : 1A31T1B4M2QES

ACTUATOR OPTIONS

Actuator shown with standard B4 Bushing, Subtract .085 (2.15) for B1 bushing.

T1

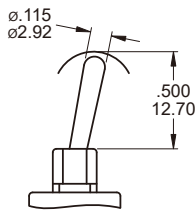

T2

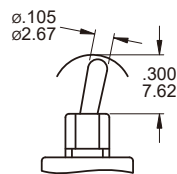

TA

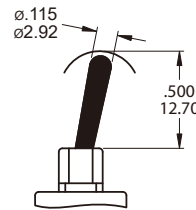

TB

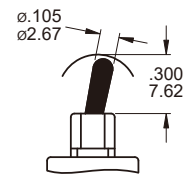

PLASTIC ACTUATOR (TC,Silver)

BUSHING OPTIONS

B1

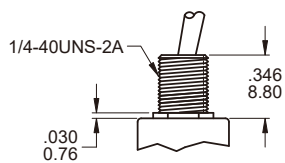

Std for M1

B4

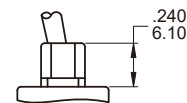

Std for M2, M6, M7, VS termination

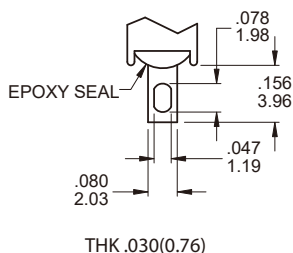
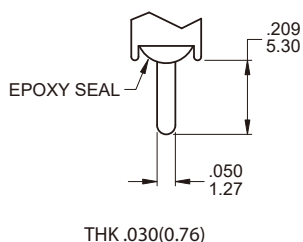
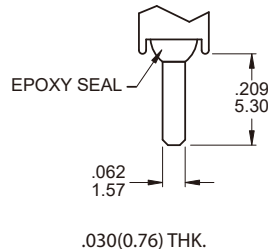
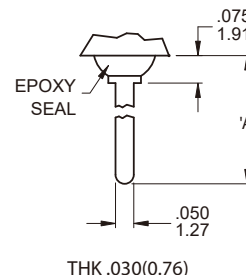
TERMINATION OPTIONS
M1 Solder lug

M2 PC Thru-hole

M3 Quick connect

M5 Wire Wrap

OTHER TERMINATION OPTIONS
M6 Right angle P.C. Mount

M7 Vertical right angle P.C. Mount

VS2 Vertical bracket P.C. Mount

VS3 Vertical bracket P.C. Mount

M6N Right angle P.C. Mount with snap-in bracket

V2N Vertical bracket P.C. Mount with snap-in bracket

OPTION CODE	DIM. 'A'
M51	.736 (18.70)
M52	.953 (24.20)
M53	.415 (10.55)
M54	1.062 (26.97)

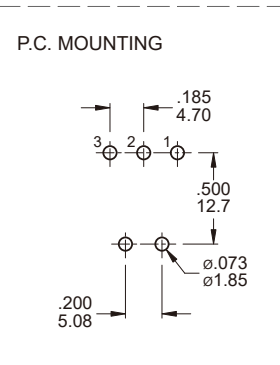
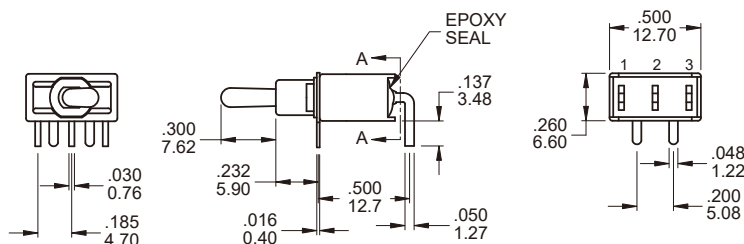
M6

SPDT

Part No. Shown : 1AS1T2B4M6QES

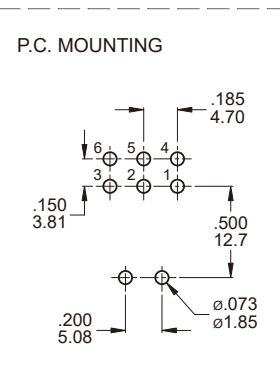
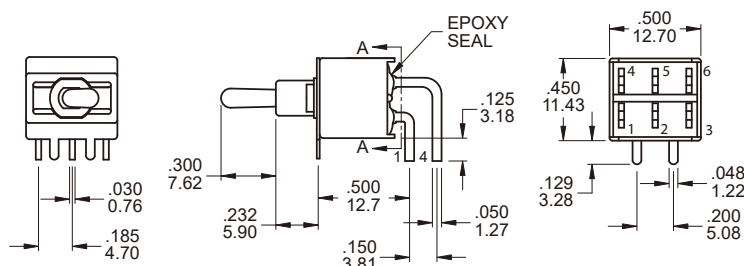
 SECTION A-A
 TERM. NOS. FOR
 REFERENCE ONLY

M6

DPDT

Part No. Shown : 1AD1T2B4M6QES

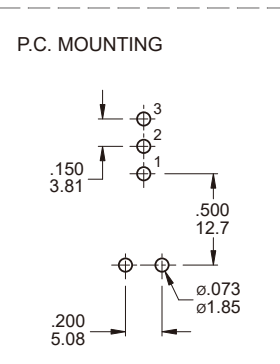
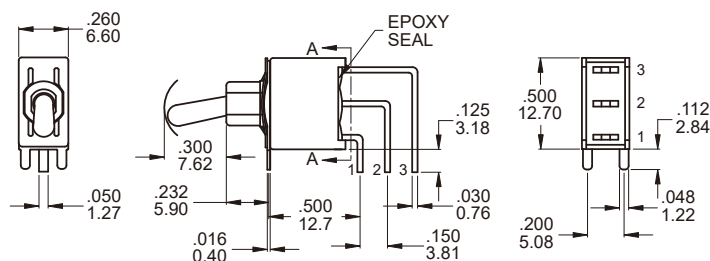
 SECTION A-A
 TERM. NOS. FOR
 REFERENCE ONLY

M7

SPDT

Part No. Shown : 1AS1T2B4M7RES

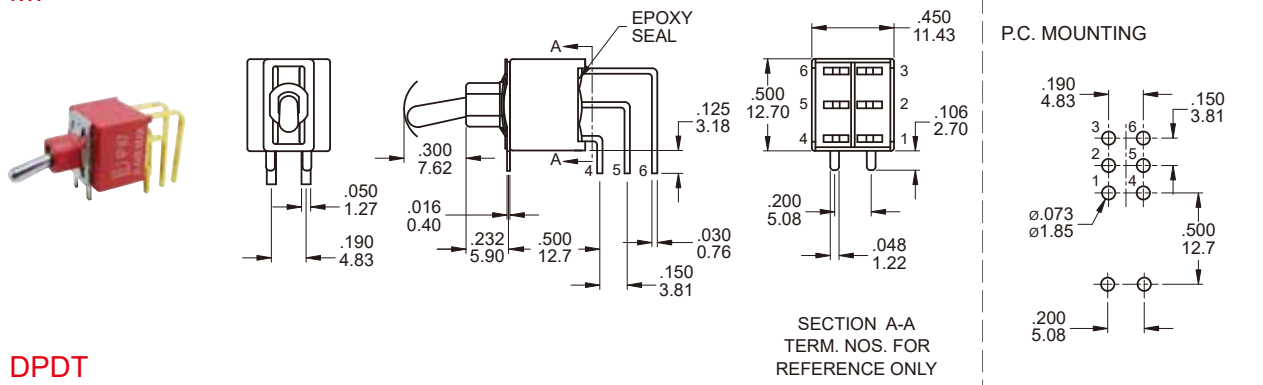
 SECTION A-A
 TERM. NOS. FOR
 REFERENCE ONLY

M7

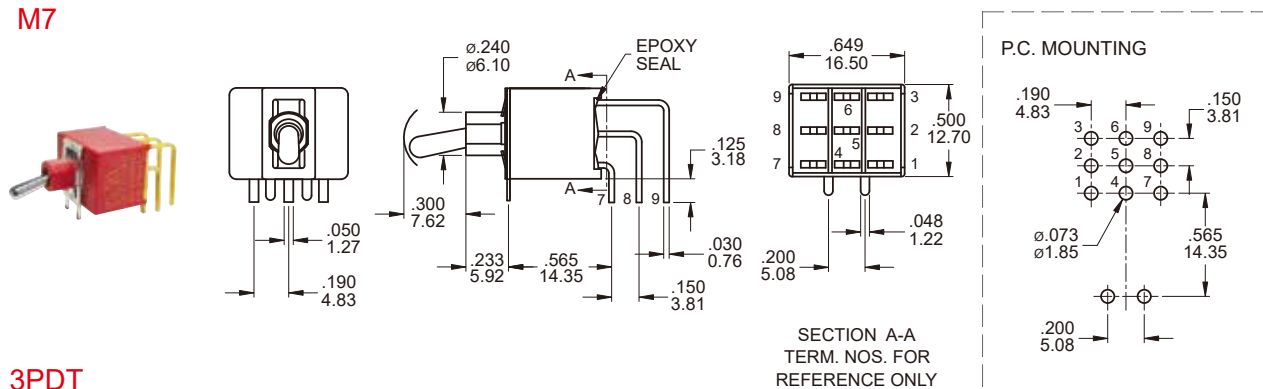
DPDT

Part No. Shown : 1AD1T2B4M7RES

M7

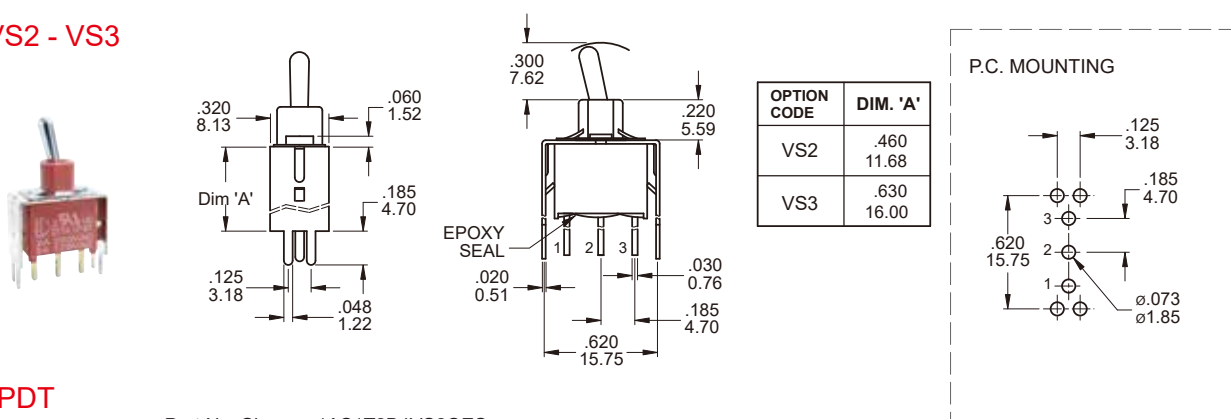
3PDT

Part No. Shown : 1A31T2B4M7QES

VS2 - VS3

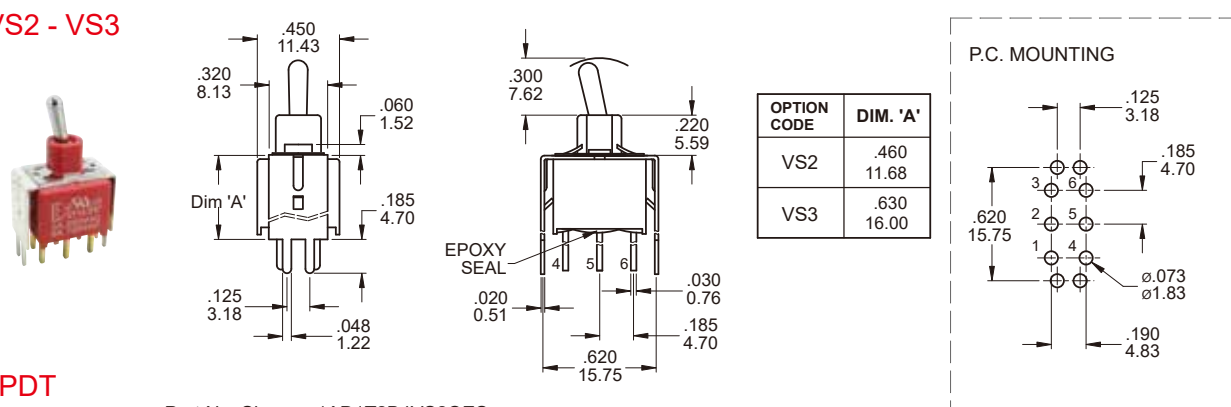
SPDT

Part No. Shown : 1AS1T2B4VS2QES

VS2 - VS3

DPDT

Part No. Shown : 1AD1T2B4VS2QES

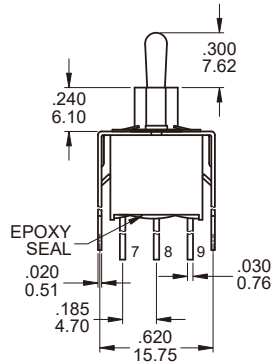
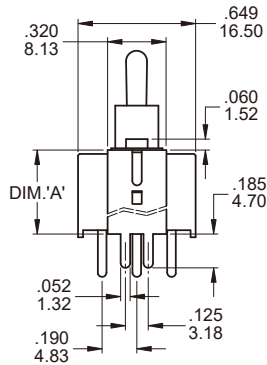

VS2 - VS3



OPTION CODE	DIM. 'A'
VS2	.460 11.68
VS3	.630 16.00

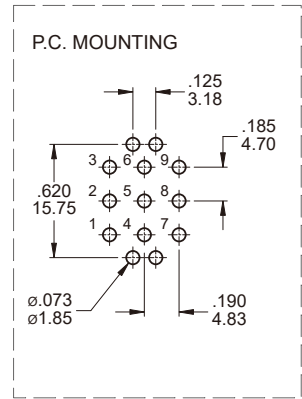

3PDT

Part No. Shown : 1A31T2B4VS2QES

SNAP-IN TERMINATION OPTIONS

M6N

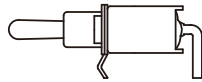
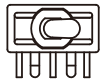

V2N

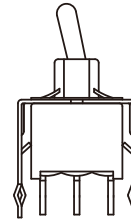

HARDWARE

1/4 NUT

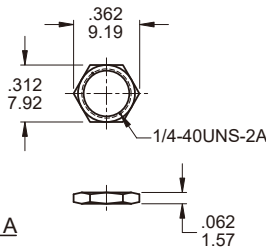

MNU-1M01A

LOCKING RING

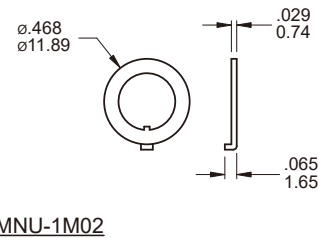

MNU-1M02

LOCKWASHER

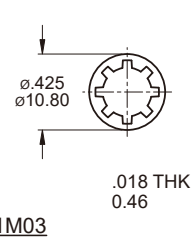

MNU-1M03

CONTACT MATERIAL OPTIONS

	CONTACT PLATING	TERMINAL PLATING	RATINGS
Q	Silver	Gold flash over silver	5 Amps with resistant load @ 120VAC or 28VDC 2 Amps with resistant load @ 250VAC
C	Gold over Silver	Gold over silver	
R	Gold	Gold	0.4 Volt - Amps (VA) max. @ 20V max. (AC or DC)

SOLDERING PROCESSES

MANUAL SOLDERING: Use soldering iron of 30 watts, controlled at 350°C approximately 5 seconds while applying solder.

WAVE SOLDERING: Recommended Soldering Temperature: 270 ± 5°C

Duration of Solder Immersion: Max 5 sec. (PCB is 1.6mm in thickness)

SPECIFICATIONS
CONTACT RATING: 0.4Volt-Amps(VA) max.@20V max(AC or DC)

MECHANICAL LIFE: 100,000 make-and-break cycles.

ELECTRICAL LIFE: 50,000 cycles.

CONTACT RESISTANCE: 10 mΩ max. initial @ 2-4VDC
100mA for both silver and gold plated contacts.

INSULATION RESISTANCE: 1,000 MΩ min.

DIELECTRIC STRENGTH: 1,000 V RMS@sea level.

OPERATING TEMPERATURE: -30°C to 85°C.

GENERAL SPECIFICATIONS
TORQUE: 0.8Nm max. applied to unt.

PANEL THICKNESS: 6mm max. ,2mm min.

MATERIALS
CASE & BUSHING: Glass filled nylon 6/6, flame retardant, heat stabilized (UL94v-0).

ACTUATOR: Brass, chrome plated with internal, O-ring seal standard.

SWITCH SUPPORT: Brass or steel, tin plated.

CONTACT / TERMINALS: Copper alloy, gold plated.

SEALIND: IP67.

 IP 67
ACCORDING TO
EN 60529:1991+A1:2001
IEC 60529:2001

SWITCH FUNCTION

NO. POLES	MODEL NO.	SWITCH FUNCTION			CONNECTED TERMINALS / SCHEMATIC		
		POS.1	POS.2	POS.3	POS.1	POS.2	POS.3
SP	1AS1	ON	NONE	ON	2-3	N/A	2-1
	1AS2	ON	NONE	MOM			
	1AS3	ON	OFF	ON			
	1AS4	MOM	OFF	MOM			OPEN
	1AS5	ON	OFF	MOM			
	1AS9	ON	NONE	OFF	2-3	N/A	OPEN
	1ASD	MOM	NONE	OFF			

MOM=MOMENTARY

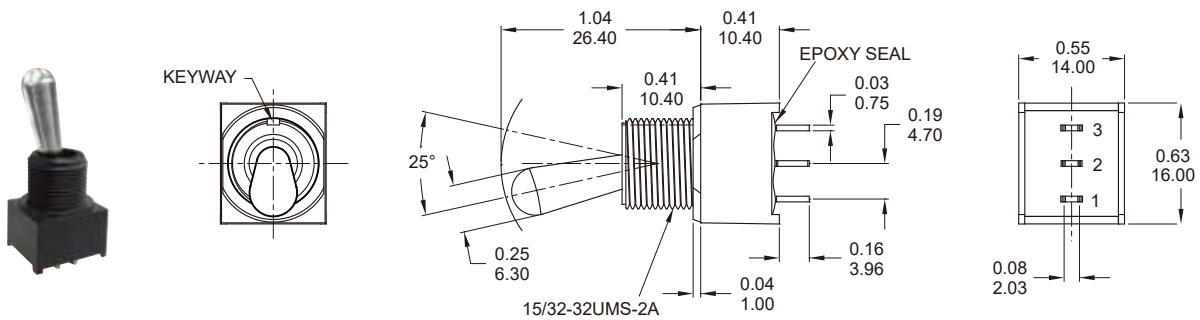
M1

Part No. Shown : 1AS1T8B22M1RPES

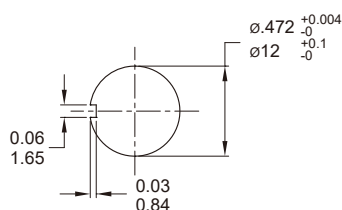
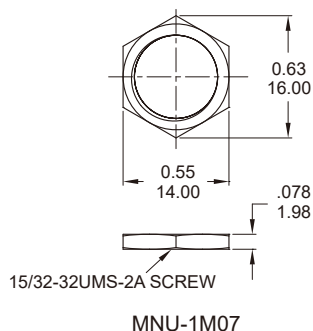
PANEL MOUNTING / HARDWARE
PANEL MOUNTING

NUT

SEALING BOOTS
